

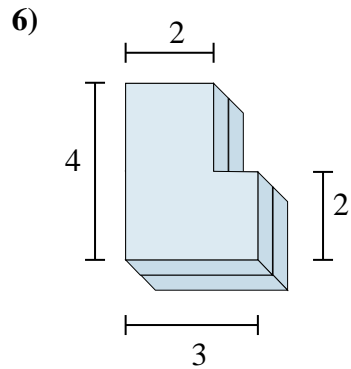

Find the total volume of each figure shown. Measured in cm (not to scale).

Answers

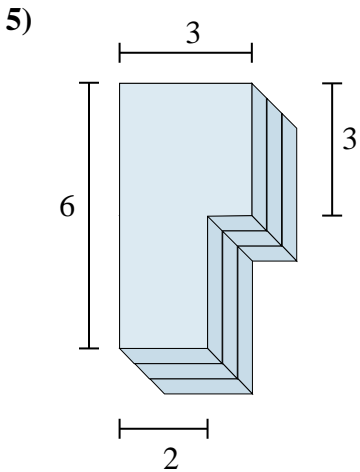
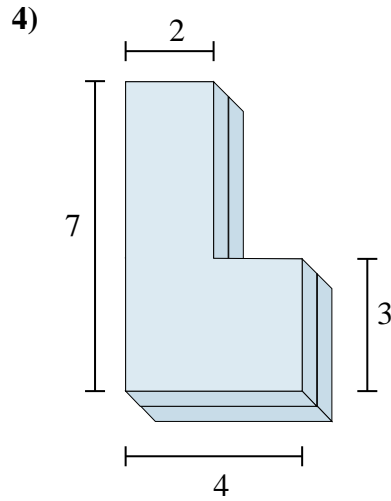
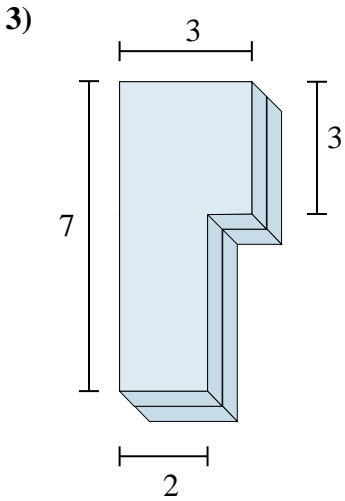
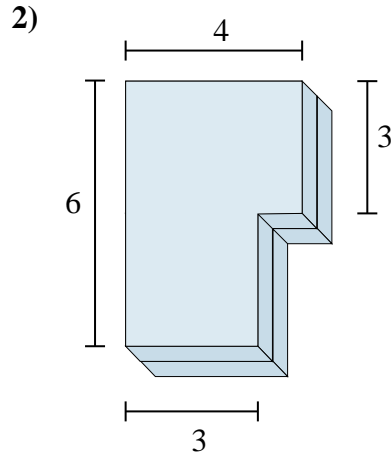
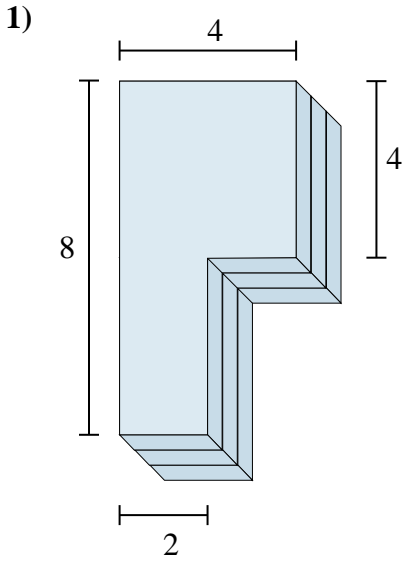

1. \_\_\_\_\_
2. \_\_\_\_\_
3. \_\_\_\_\_
4. \_\_\_\_\_
5. \_\_\_\_\_
6. \_\_\_\_\_



Find the total volume of each figure shown. Measured in cm (not to scale).

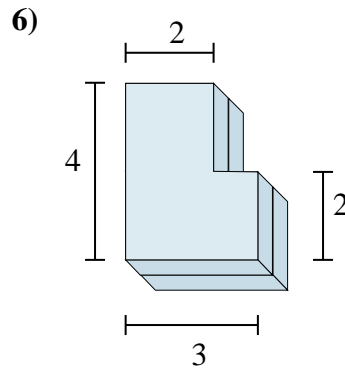
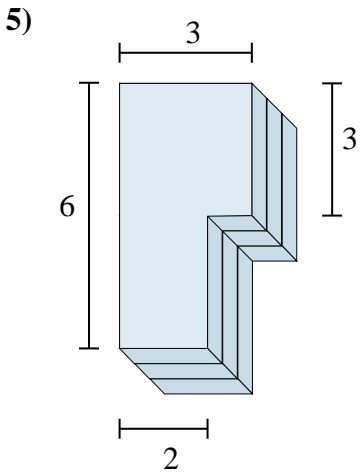
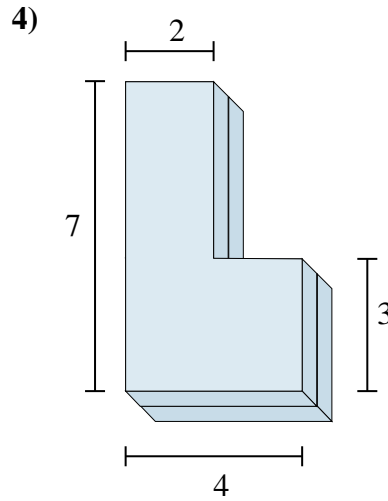
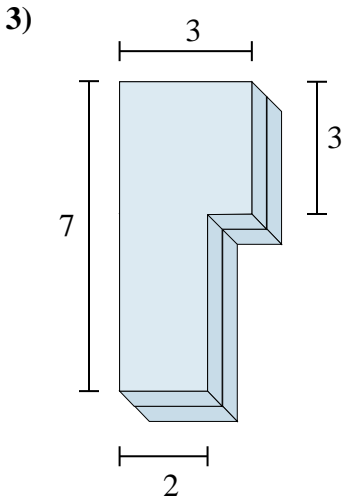
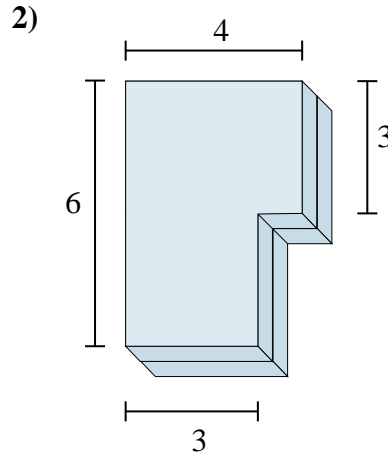
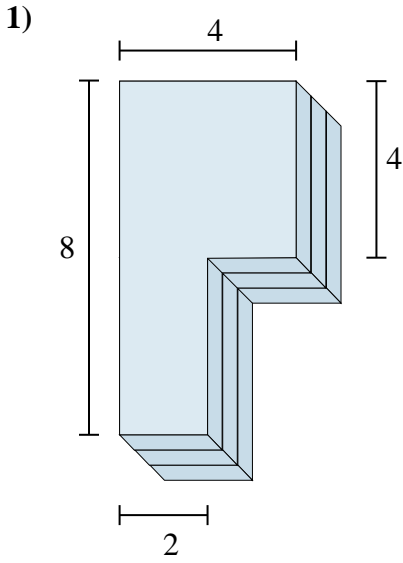

Answers

1. 72 cm<sup>3</sup>

2. 42 cm<sup>3</sup>

3. 34 cm<sup>3</sup>

4. 40 cm<sup>3</sup>

5. 45 cm<sup>3</sup>

6. 20 cm<sup>3</sup>



Find the total volume of each figure shown. Measured in cm (not to scale).

Answers

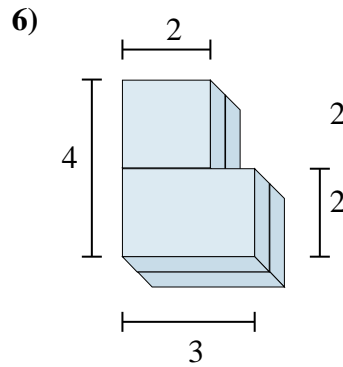
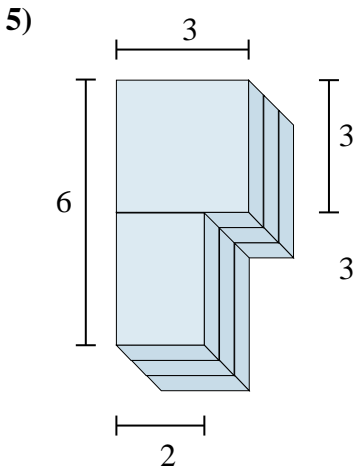
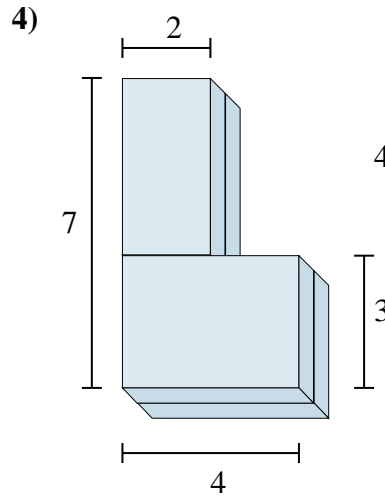
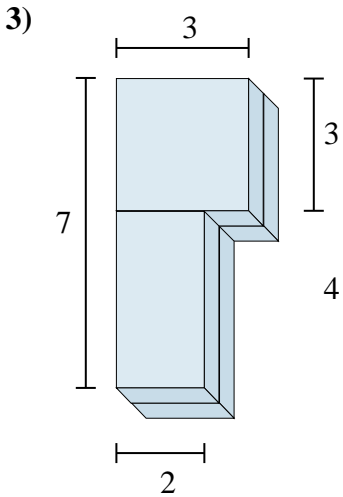
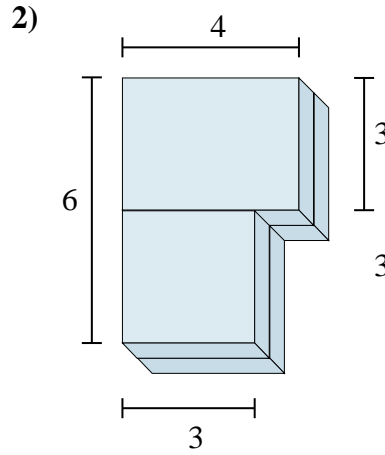
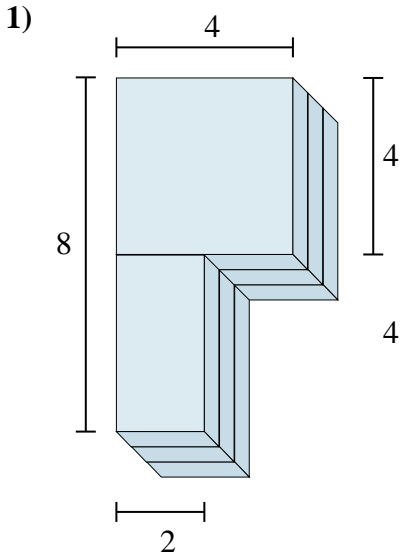

1. \_\_\_\_\_
2. \_\_\_\_\_
3. \_\_\_\_\_
4. \_\_\_\_\_
5. \_\_\_\_\_
6. \_\_\_\_\_